



ROHS-Compliant Product

Monolith-Filters

metal can package



Description:

- 2 pole Filters
- 4-Pol Filter, cascaded by two UM-1 2-Pol Filters

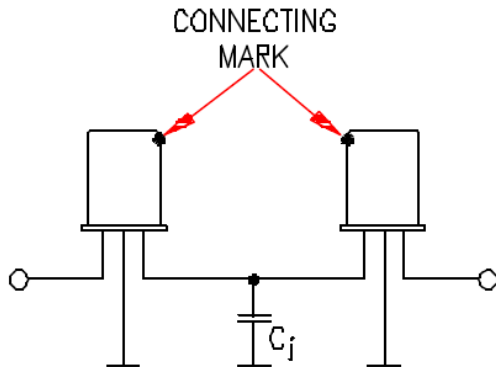

FEATURES:

- high attenuation in the stop band
- hermetic sealed
- RoHS, PB-free

APPLICATIONS:

Examples of our product range ≤ 10.7 MHz

Type	Frequency	Case Style	Passband		Stopband		Termination in/out	POLE	Insertion loss max.
	MHz		dB	\pm kHz	dB	\pm kHz	(Ω)		dB
XF-50-LF	5,00	BF17	3	10	10	25	56000//1,3 pf	2	3
XF-55-LF	5,50	BF17	3	4	20	19	13000// -1,5 pf	2	1
XF-810-LF	8,00	BF17	3	7,5	30	45	13000	2	0,5
XF-914-LF	9,00	BF17	3	1,2	30	12	3300// 6 pf	2	1
XF-915-LF	9,00	BF17	3	3,75	30	25	5700// 2 pf	2	1
XF-920PAAR-LF	9,00	BF17 p)	3	7,5	40	25	6000	4	2
XF-916-LF	9,023	BF17	3	1,5	30	15	2200	2	3
XF-125-LF	10,00	BF17	3	0,05	3	3	2000//4,7pf	2	3
XFD-100S02-LF	10,00	BF17	3	3,75	15	12,5	1500	2	1
XF-306PAAR-LF	10,00	BF17 p)	3	7,5	40	25	5500	4	2

KVG Quartz Crystal Technology GMBH

D-74922 Neckarbischofsheim P.O.B. 61 74924 Neckarbischofsheim Waibstadter Strasse 2 - 4
 Tel: +49 (0) 7263 / 648 - 0 Fax: +49 (0) 7263 / 6196 e-mail: info@kvg-gmbh.de



ROHS-Compliant Product

Monolith-Filters

metal can package



Examples of our product range ≤ 10.7 MHz

Type	Frequency	Case Style	Passband		Stopband		Termination in/out	POLE	Insertion loss max.
	MHz		dB	\pm kHz	dB	\pm kHz	(Ω)		dB
XF-118-LF	10,00	BF17	3	10	20	37,5	2500// -3 pf	2	0,5
XF-123-LF	10,24	BF17	3	3,8	30	40	3900// 2 pf	2	1
XF-107-LF	10,697	BF17	3	7,5	25	30	5000	2	0,5
XF-124A-LF	10,70	BF17	3	2,5	30	20	1500// 4 pf	2	1
XF-303PAAR-LF	10,70	BF17 p)	3	3,75	40	14	2200// 4 pf	4	2
XF-106-LF	10,70	BF17	3	3,75	25	15	1500	2	0,5
XF-104A-LF	10,70	BF17	3	6	20	25	2500// 1 pf	2	1,5
XF-302PAAR-LF	10,70	BF17 p)	3	6	40	20	3900	4	2
XF-110PAAR-LF	10,70	BF17 p)	3	7	30	23	10000	4	4,5
XFD-107S03-LF	10,70	BF17	3	10	20	50	3000// -3 pf	2	1,5
XF-304PAAR-LF	10,70	BF17 p)	3	10	30	25	6000	4	2
XFD-107U-LF	10,70	BF17 p)	3	15	40	50	5000// -0,5pf	4	2
XF-101-LF	10,70	BF17	3	7,5	18	25	3000	2	1
XFD-107S02-LF	10,70	BF17	3	25	25	100	15000// -1 pf	2	1
XF-301PAAR-LF	10,70	BF17 p)	3	7,5	40	25	4700// 0,5pf	4	2

Note p): 4-Pol Filter, cascaded by two UM-1 2-Pol Filters

KVG Quartz Crystal Technology GMBH

D-74922 Neckarbischofsheim P.O.B. 61 74924 Neckarbischofsheim Waibstadter Strasse 2 - 4
 Tel: +49 (0) 7263 / 648 - 0 Fax: +49 (0) 7263 / 6196 e-mail: info@kvg-gmbh.de



ROHS-Compliant Product

Monolith-Filters

metal can package



Case Style BF17

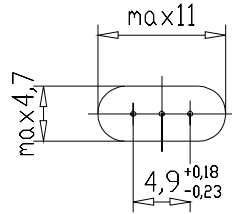

DIN IEC 49(CO)208
Typ F16

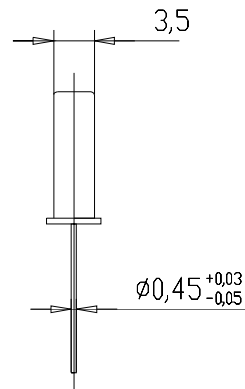
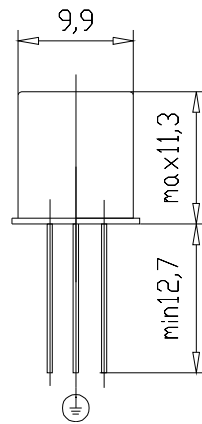

Case Style BF18

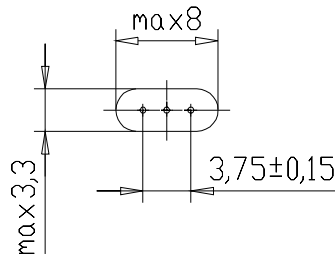

DIN IEC 49(CO)208
Typ F15

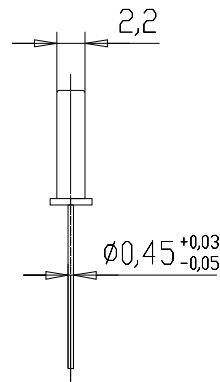
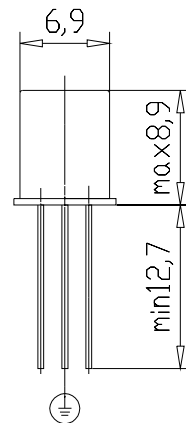

KVG Quartz Crystal Technology GMBH

D-74922 Neckarbischofsheim P.O.B. 61 74924 Neckarbischofsheim Waibstadter Strasse 2 - 4
Tel: +49 (0) 7263 / 648 - 0 Fax: +49 (0) 7263 / 6196 e-mail: info@kvg-gmbh.de