



ROHS-Compliant Product

# Monolith-Filters

metal can package



## Description:

- 2 pole Filters
- 4-Pol Filter, cascaded by two UM-1 2-Pol Filters

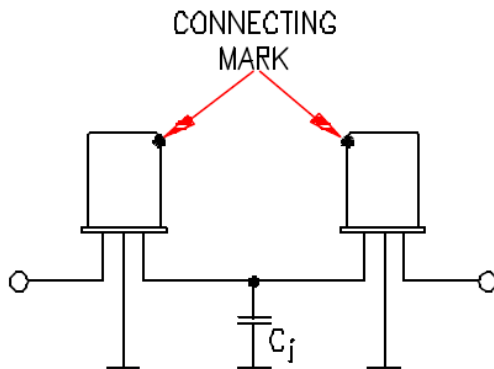

## FEATURES:

- high attenuation in the stop band
- hermetic sealed
- RoHS, PB-free

## APPLICATIONS:

### KVG Quartz Crystal Technology GMBH

D-74922 Neckarbischofsheim P.O.B. 61 74924 Neckarbischofsheim Waibstadter Strasse 2 - 4  
Tel: +49 (0) 7263 / 648 - 0 Fax: +49 (0) 7263 / 6196 e-mail:info@kvg-gmbh.de



# Monolith-Filters

metal can package

ROHS-Compliant Product



## Examples of our product range > 21.4 MHz

Type	Frequency	Case Style	Passband		Stopband		Termination in/out	POLE	Insertion loss max.
	MHz		dB	± kHz	dB	± kHz	(Ω)		dB
XF-214PAAR-LF	21,450	BF18 p)	3	3	20	10	1250// 1 pf	4	2
XF-230-LF	21,616	BF17	3	3,75	24	15	1300// 5 pf	2	3
XFD-218S01-LF	21,855	BF18	3	6	20	25	910// 3 pf	2	1,5
XF-250PAAR-LF	24,968	BF17 p)	3	13	20	60	2200	4	2
XFD-260S01-LF	26,00	BF18	3	30	30	500	4000// -0,6 pf	2	0,5
XFD-265S01-LF	26,50	BF18	3	10	20	100	2500// -1 pf	2	3
XF-312PAAR-LF	30,00	BF18 p)	3	6,5	15	10	2300// 1 pf	4	3
XF-300S12-LF	30,00	BF18	3	50	20	250	3000	2	2
XF-311-LF	31,00	BF18	3	14	30	100	2000// 1,4 pf	2	1
XF-350-LF	35,00	BF18	3	15	20	80	2000// 0,5 pf	2	1
XF-382-LF	38,20	BF18	3	6,5	20	30	3500// -2 pf	2	2
XF-358-LF	38,808	BF17	3	17	30	100	2200	2	1
XFD-400S01-LF	40,00	BF18	3	30	30	500	2000	2	5
XF-406S06-LF	40,695	BF18	3	7,5	15	30	2700	2	3
XF-414-LF	41,00	BF18	3	3,5	30	40	1500// -2 pf	2	1,5
XFD-420S01-LF	42,00	BF18	3	5	25	40	2200// -1,5 pf	2	3
XF-421-LF	42,088	BF18	3	3,5	25	25	1900// -0,5 pf	2	2
XF-425S01-LF	42,50	BF18	3	5	85	37,5	2400// 1 pf	4	5
XF-436-LF	43,639	BF18	2	6	25	1200	3300	2	5
XFD-450S05-LF	45,00	BF18 p)	3	7,5	30	25	650// 3 pf	4	3
XF-451-LF	45,00	BF18	3	10	15	25	3000// -1 pf	2	1,5
XF-415-LF	48,00	BF17	3	3	20	20	470// 1 pf	2	3
XFD-500S01-LF	50,00	BF18	3	3,5	25	25	900	2	2
XF-518S01-LF	51,84	BF18	3	6	15	24	1000	2	3
XFD-700S01-LF	70,00	BF18 p)	3	7,5	40	30	3000// -0,5 pf	4	2
XFD-750S01-LF	75,00	BF17	6	13	40	200	4000// -0,6 pf	2	6

Note p): 4-Pol Filter, cascaded by two UM-1 2-Pol Filters

### KVG Quartz Crystal Technology GMBH

D-74922 Neckarbischofsheim P.O.B. 61 74924 Neckarbischofsheim Waibstadter Strasse 2 - 4  
 Tel: +49 (0) 7263 / 648 - 0 Fax: +49 (0) 7263 / 6196 e-mail:info@kvg-gmbh.de



ROHS-Compliant Product

# Monolith-Filters

metal can package



## Case Style BF17

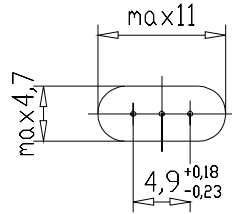

DIN IEC 49(CO)208  
Typ F16

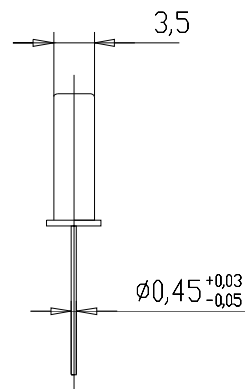
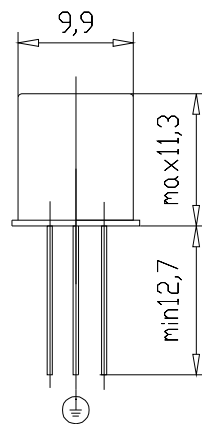

## Case Style BF18

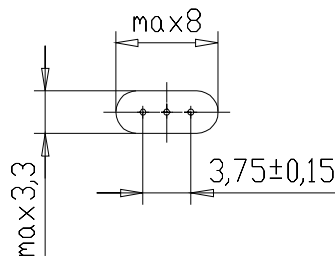

DIN IEC 49(CO)208  
Typ F15

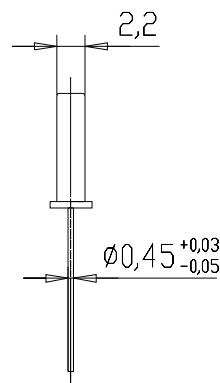
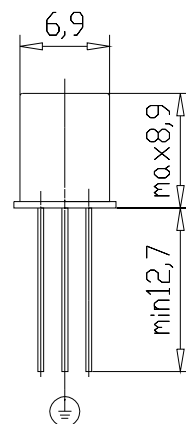

**KVG Quartz Crystal Technology GMBH**

D-74922 Neckarbischofsheim P.O.B. 61 74924 Neckarbischofsheim Waibstadter Strasse 2 - 4  
Tel: +49 (0) 7263 / 648 - 0 Fax: +49 (0) 7263 / 6196 e-mail: info@kvg-gmbh.de